

## EXERCISE 17A

For SSC GD and MTS Exams

1. Select the correct answer.

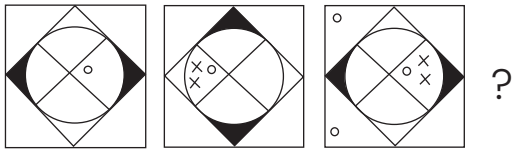

SSC MTS 02/11/2021 (Shift-3)

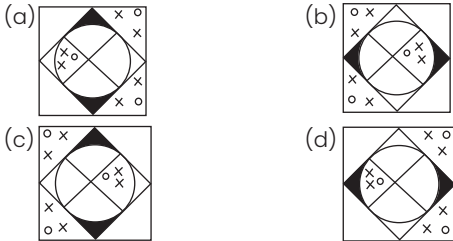

2. Select the correct answer.

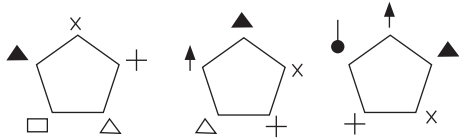

SSC MTS 02/11/2021 (Shift-2)

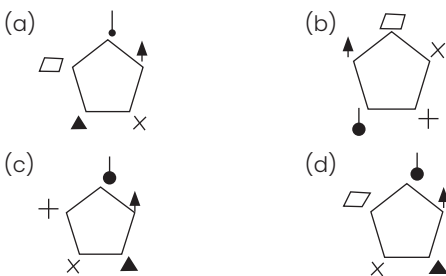

3. Select the correct answer.



SSC MTS 02/11/2021 (Shift-1)

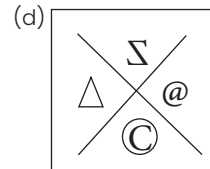
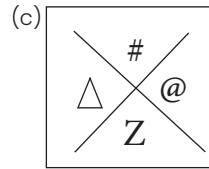
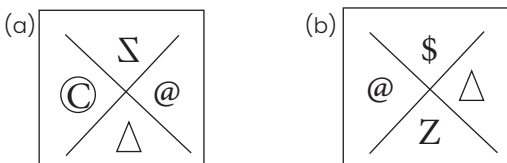

4. Select the correct answer.

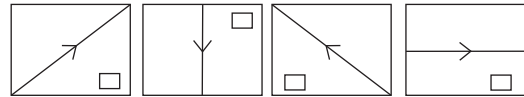

SSC MTS 27/10/2021 (Shift-3)

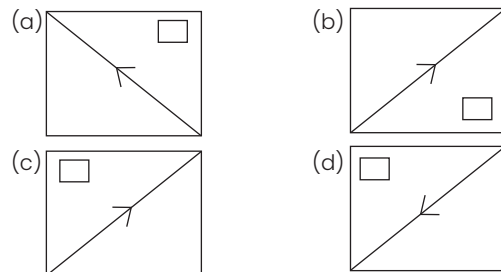

5. Select the correct answer.

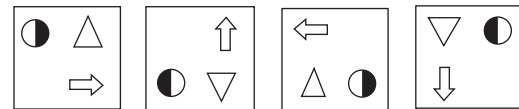

SSC MTS 27/10/2021 (Shift-2)

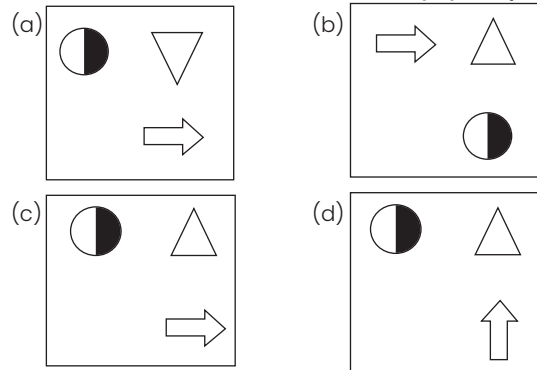

6. Select the correct answer.

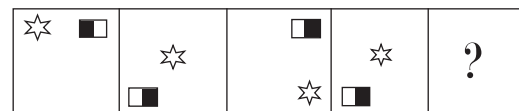

SSC MTS 27/10/2021 (Shift-1)

2 ■ SSC Reasoning

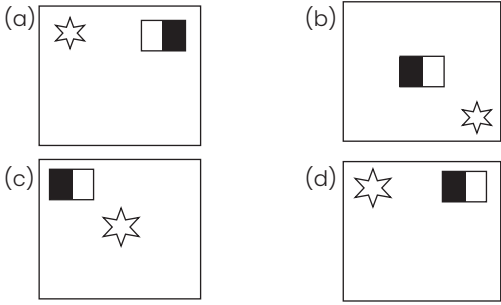

7. Select the correct answer.

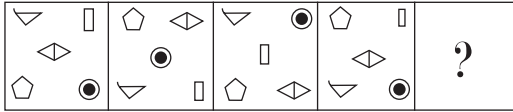

SSC MTS 26/10/2021 (Shift-3)

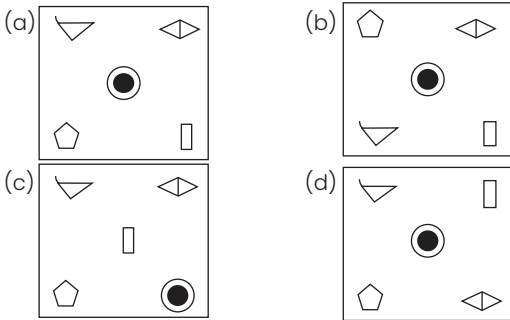

8. Select the correct answer.

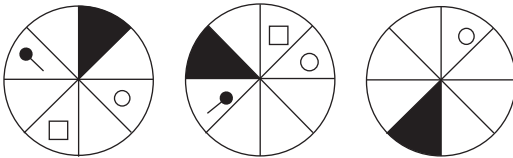

SSC MTS 26/10/2021 (Shift-2)

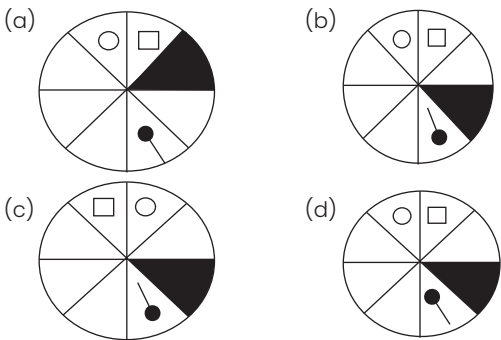

9. Select the correct answer.

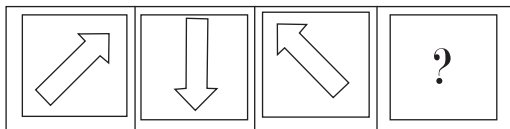

SSC MTS 26/10/2021 (Shift-1)

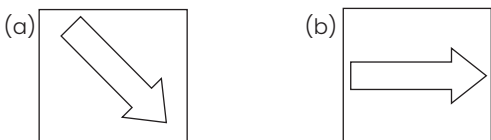

10. Select the correct answer.

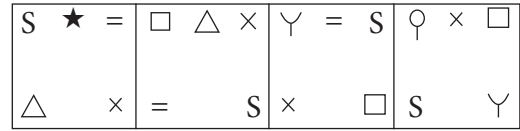

SSC MTS 22/10/2021 (Shift-2)

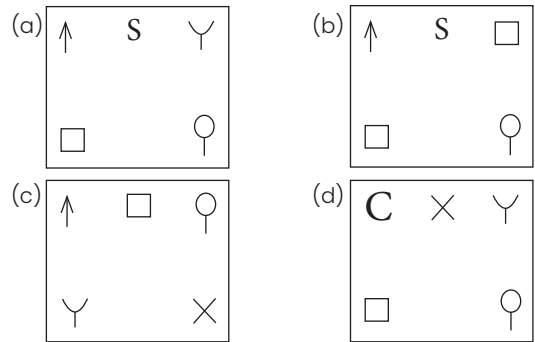

11. Select the correct answer.

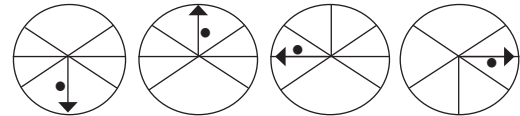

SSC MTS 22/10/2021 (Shift-1)

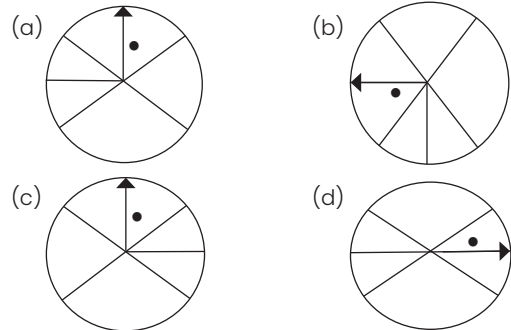

12. Select the correct answer.

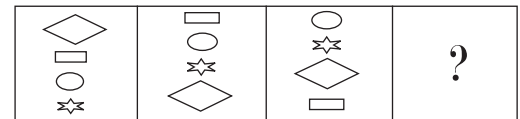

SSC MTS 20/10/2021 (Shift-3)

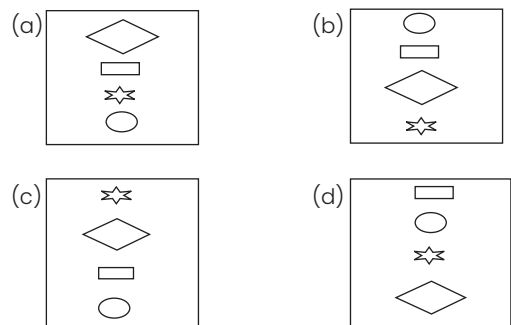

13. Select the correct answer.

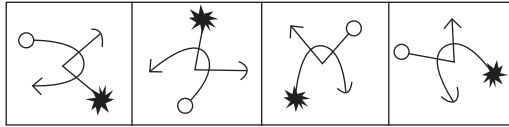

SSC MTS 20/10/2021 (Shift-2)

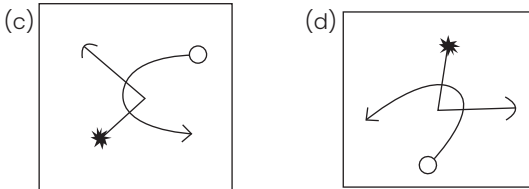
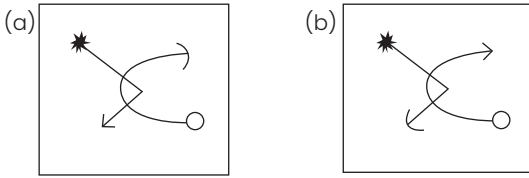

14. Find which figure is to be removed so that all, starting from I, fit into a pattern.

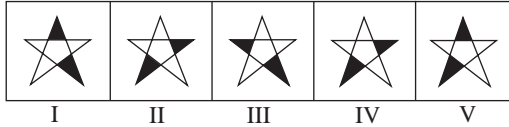

SSC MTS 20/10/2021 (Shift-1)

(a) II (b) V (c) IV (d) III

15. Select the correct answer.

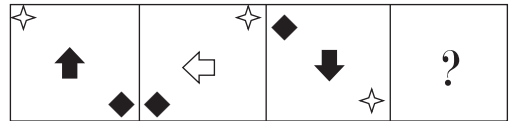

SSC MTS 18/10/2021 (Shift-3)

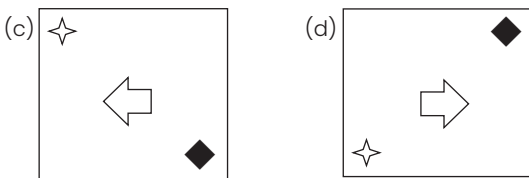
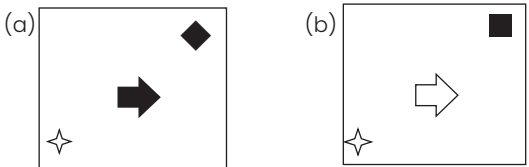

16. Select the correct answer.

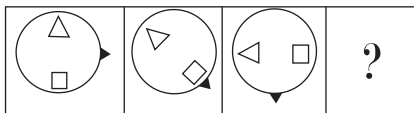

SSC MTS 18/10/2021 (Shift-2)

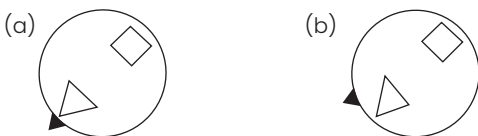

17. Select the correct answer.

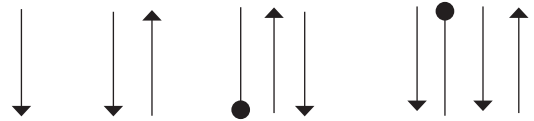
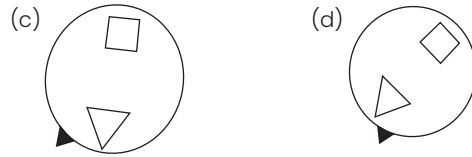

SSC MTS 18/10/2021 (Shift-1)

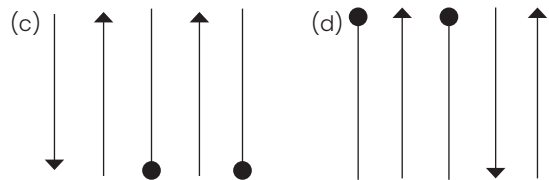
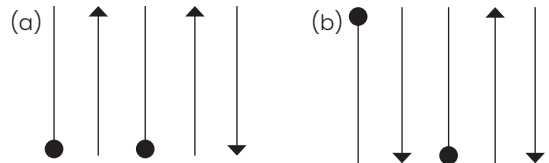

18. Select the correct answer.

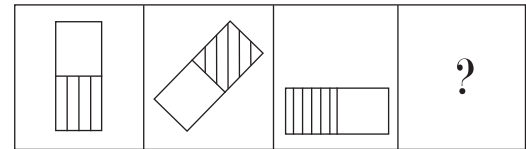

SSC MTS 14/10/2021 (Shift-3)

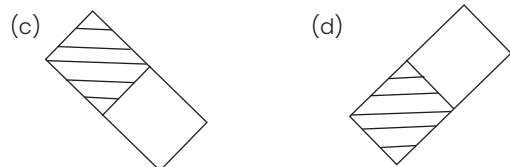
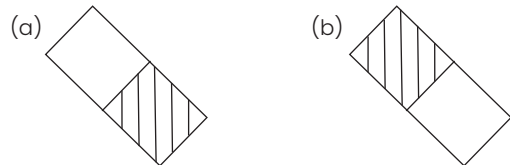

19. Select the correct answer.

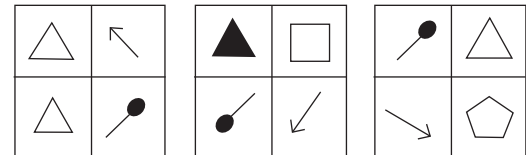

SSC MTS 14/10/2021 (Shift-2)

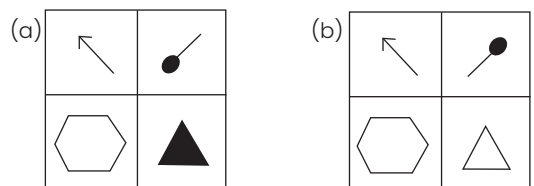

4 ■ SSC Reasoning

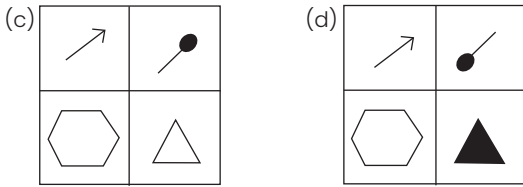

20. Select the correct answer.

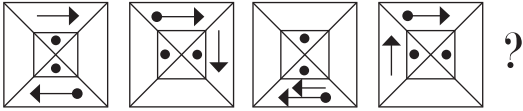

SSC MTS 14/10/2021 (Shift-1)

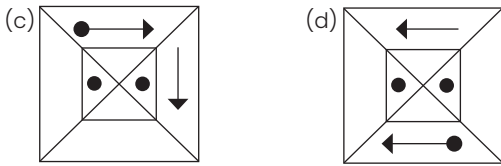
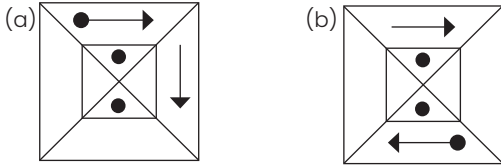

21. Select the correct answer.

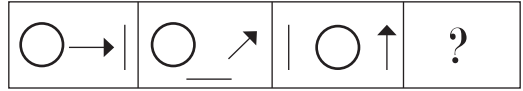

SSC MTS 13/10/2021 (Shift-3)

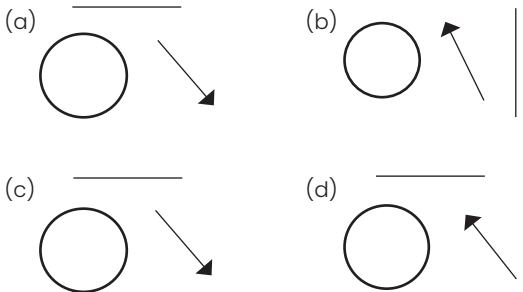

22. Select the correct answer.

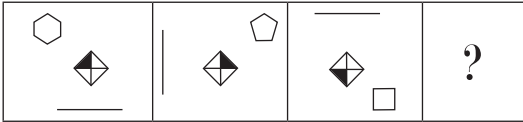

SSC MTS 13/10/2021 (Shift-2)

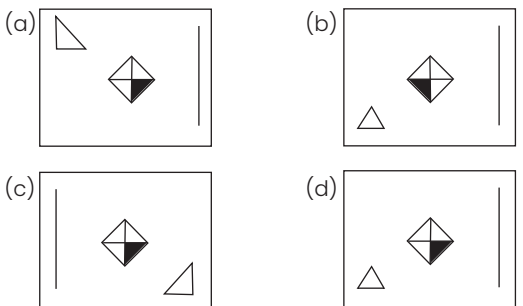

23. Select the correct answer.

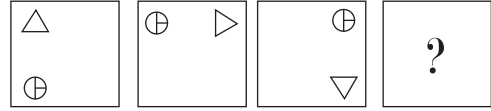

SSC MTS 22/08/2019 (Shift-3)

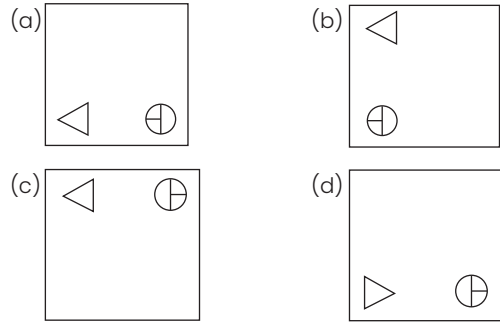

24. Select the correct answer.

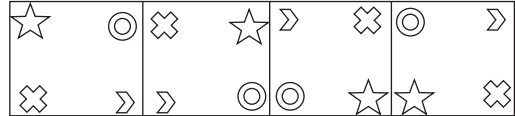

SSC MTS 22/08/2019 (Shift-1)

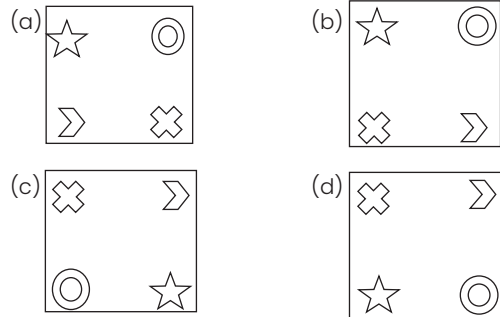

25. Select the correct answer.

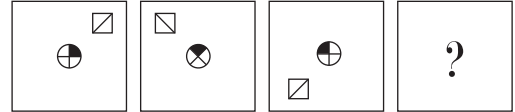

SSC MTS 21/08/2019 (Shift-3)

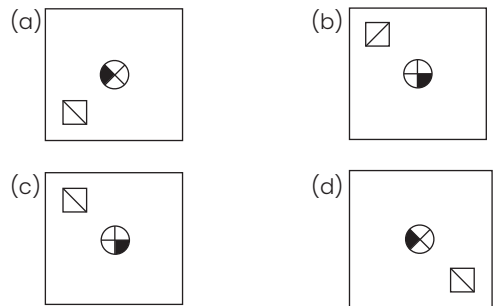

26. Select the correct answer.

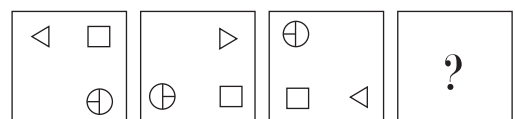

SSC MTS 21/08/2019 (Shift-2)

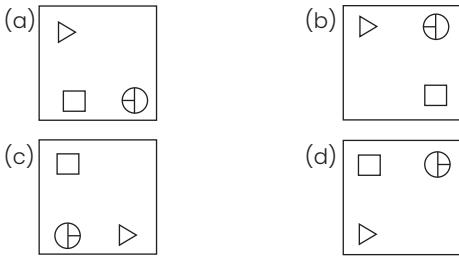

27. Select the correct answer.

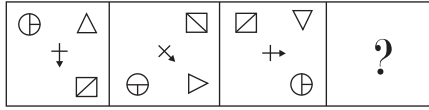

SSC MTS 21/08/2019 (Shift-1)

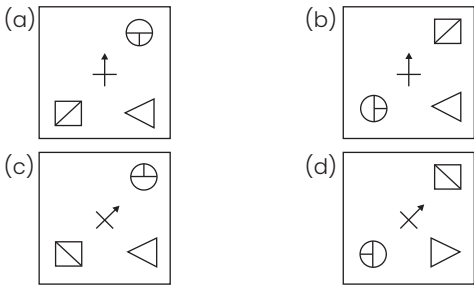

28. Select the correct answer.

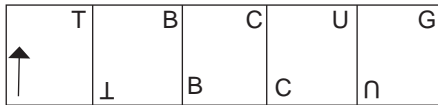

SSC MTS 20/08/2019 (Shift-3)

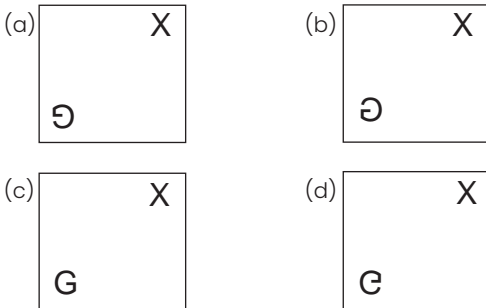

29. Select the correct answer.

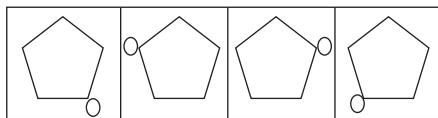

SSC MTS 20/08/2019 (Shift-2)

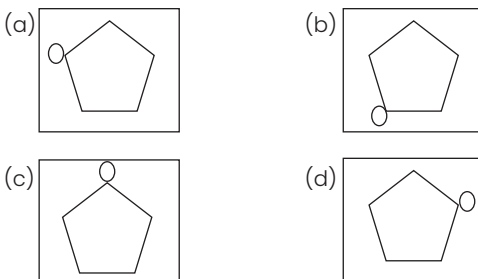

30. Select the correct answer.

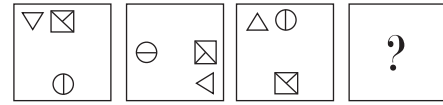

SSC MTS 20/08/2019 (Shift-1)

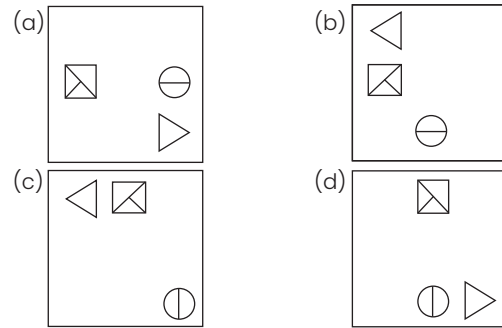

31. Select the correct answer.

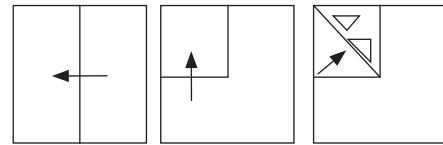

SSC MTS 20/08/2019 (Shift-1)

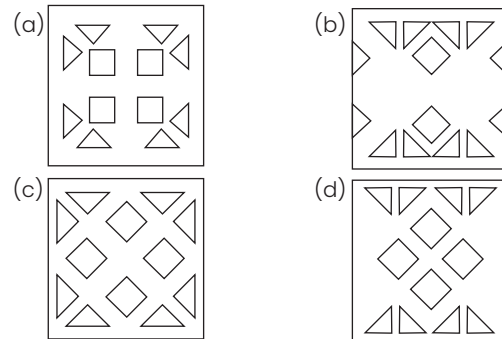

32. Select the correct answer.

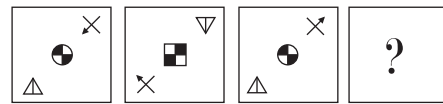

SSC MTS 19/08/2019 (Shift-3)

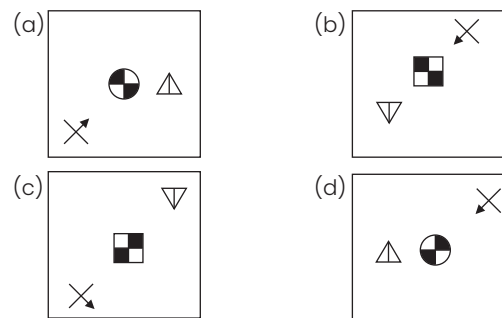

33. Select the correct answer.

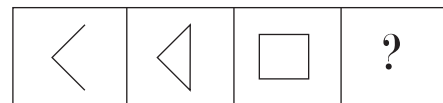

SSC MTS 19/08/2019 (Shift-2)

6 ■ SSC Reasoning

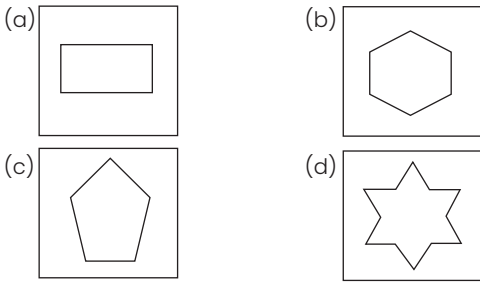

34. Select the correct answer.

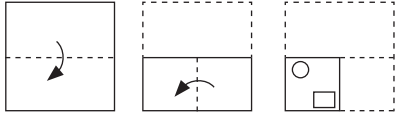

SSC MTS 16/08/2019 (Shift-3)

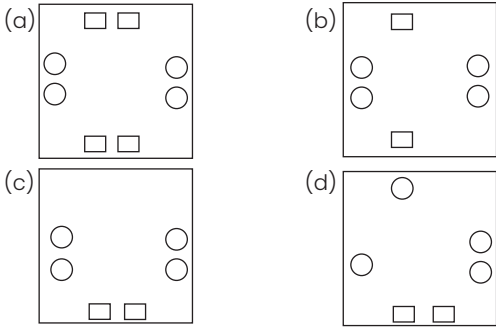

35. Select the correct answer.

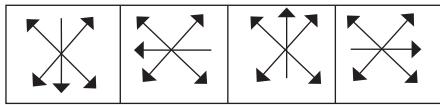

SSC MTS 16/08/2019 (Shift-3)

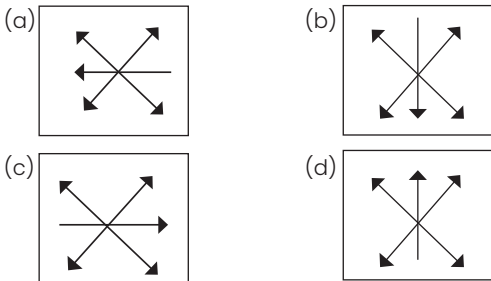

36. Select the correct answer.

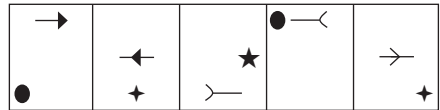

SSC MTS 16/08/2019 (Shift-2)

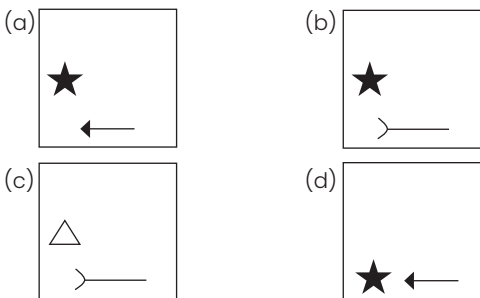

37. Select the correct answer.

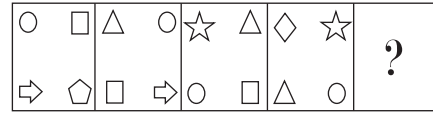

SSC MTS 14/08/2019 (Shift-3)

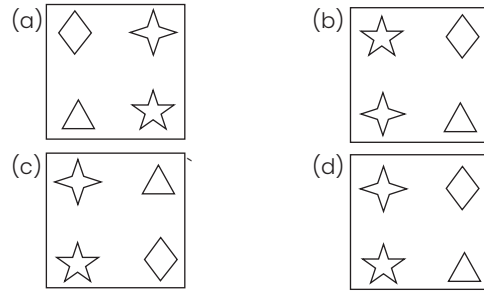

38. Select the correct answer.

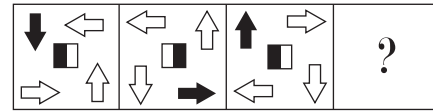

SSC MTS 14/08/2019 (Shift-2)

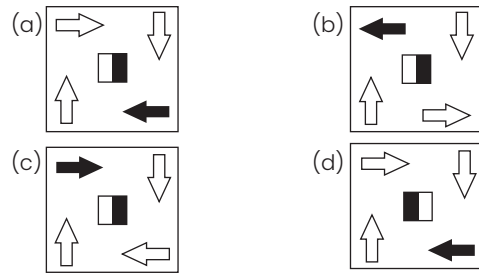

39. Select the correct answer.

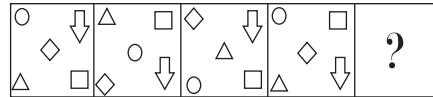

SSC MTS 14/08/2019 (Shift-1)

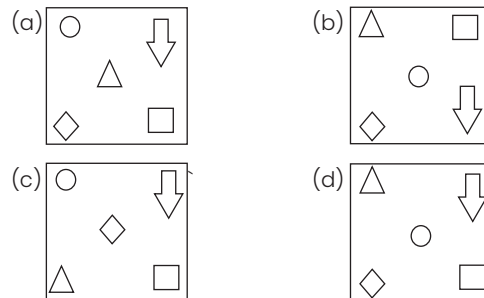

40. Select the correct answer.

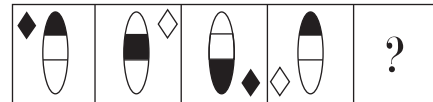

SSC MTS 13/08/2019 (Shift-2)



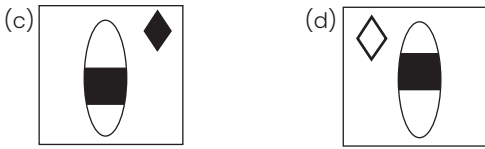

40. Select the correct answer.

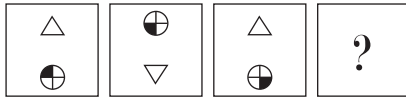

SSC MTS 13/08/2019 (Shift-1)

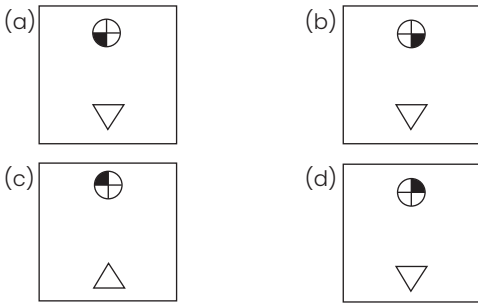

41. Select the correct answer.

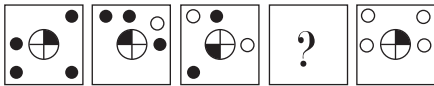

SSC MTS 09/08/2019 (Shift-3)

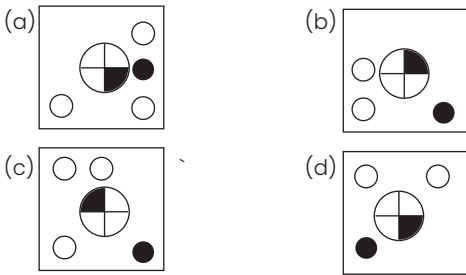

42. Select the correct answer.

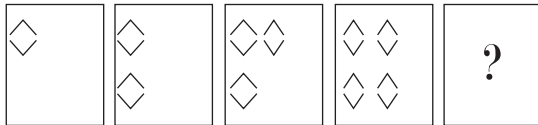

SSC MTS 09/08/2019 (Shift-1)

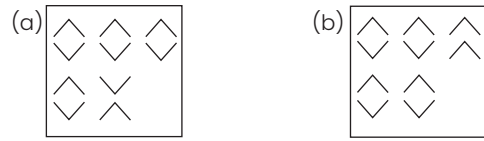

43. Select the correct answer.

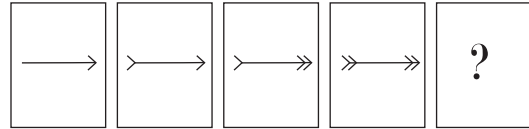

SSC MTS 08/08/2019 (Shift-3)

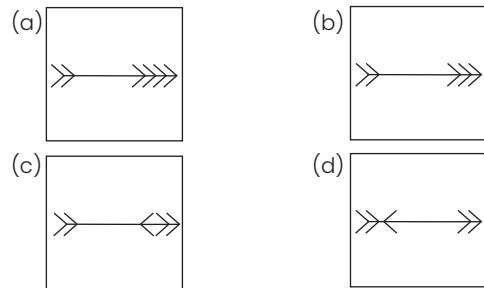

44. Select the correct answer.

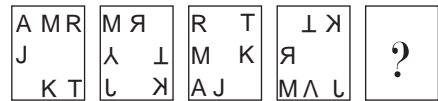

SSC MTS 08/08/2019 (Shift-2)

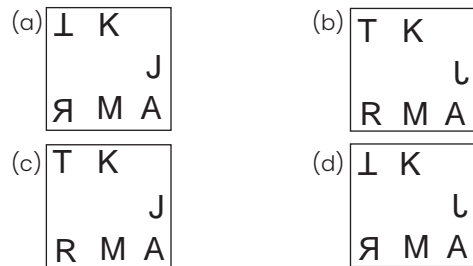

## SOLUTIONS

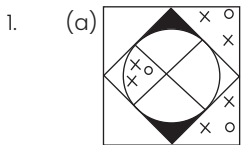

1. According to the question figure, in outer side of figure the point moved in other side and two cross is add and inner figure point and cross moved to other side. So, option (a) is correct.

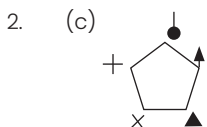

According to the question, the symbol is moved one step clockwise. So, option (c) is correct.

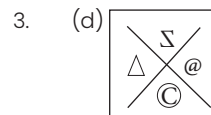

3. According to the question, the symbol is moved one step clockwise and next figure symbol is moved one step clockwise. So, option (d) is correct.

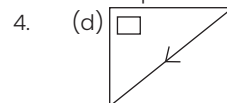

8 ■ SSC Reasoning

According to the question, the arrow is moved  $45^\circ$  anticlockwise and arrow direction is changed, and  $\square$  is moved one step anticlockwise and two step anticlockwise. So, option (d) is correct.

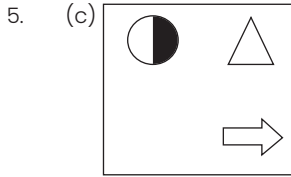

According to the question figure, circle and arrow moved one step anticlockwise and triangle moved one step clockwise and then reverse. So, option (c) is correct.

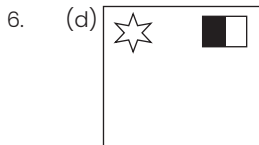

According to the question figure, rectangle moved 2 steps anticlockwise and change direction. So, option (d) is correct.

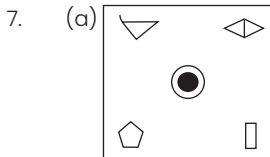

According to the question figure,  $\triangle$  and  $\Delta$  change their place step by step and other three symbol moved one step clockwise. So, option (a) is correct.

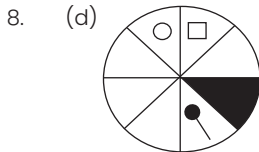

According to the question figure, dark part moved two step anticlockwise,  $p \rightarrow$  moved one step anticlockwise and reverse, circle moved one step. So, option (d) is correct.

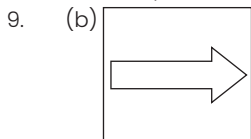

According to the question figure, arrow moved  $135^\circ$  clockwise. So, option (b) is correct.

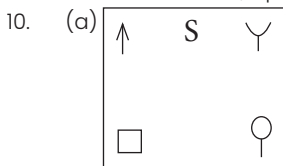

According to the question figure, S moved 2 step and one step and then moved at bottom. So, option (a) is correct.

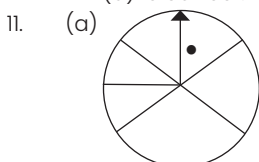

According to the question figure,  $\rightarrow$  moved first two step and next one step anticlockwise,  $\rightarrow$  moved first two step and next one step clockwise. So, option (a) is correct.

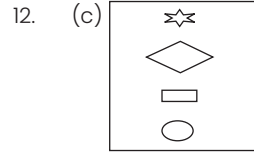

According to the question figure, fist symbol moved at last and another symbol moved one step above. So, option (c) is correct.

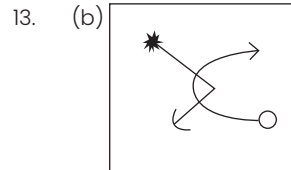

According to the question figure, the figure first moved  $45^\circ$  anticlockwise and their end is interchanged, and the second moved  $135^\circ$  clockwise their end is interchanged. So option (b) is correct.

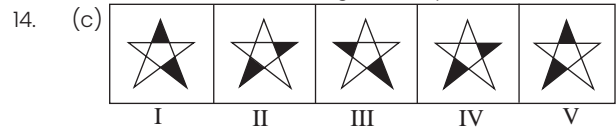

In given question figure (IV) is removed and then, figure I to all figure in a pattern. So option (c) is correct.

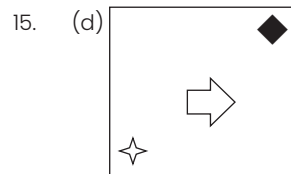

According to the question figure,  $\blacklozenge$  moved one step clockwise, and arrows moved  $90^\circ$  anticlockwise and dark. So, option (d) is correct.

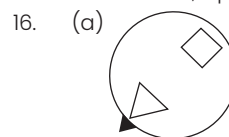

According to the question, the triangle and square moved  $45^\circ$  anticlockwise and  $\blacktriangledown$  is moved  $45^\circ$  clockwise. So, option (a) is correct.

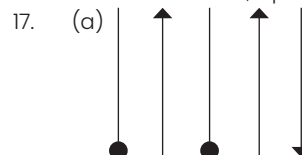

According to the question figure, first one arrow is add and reverse, next one line add and arrows are reverse. So, option (a) is correct.

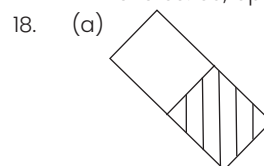



According to the question figure, figure moved 135° anticlockwise. So, option (a) is correct.

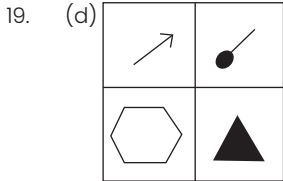

According to the question figure, all symbol moved one step clockwise and symbol change their direction. In triangle, one side is added. So, option (d) is correct.

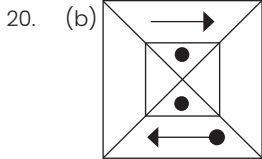

According to the question figure,  $\rightarrow$  moved one step clockwise and  $\bullet$  moved two step clockwise. So, option (b) is correct.

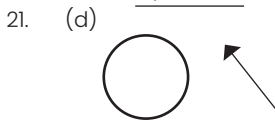

According to the question figure, line move one step clockwise and  $\uparrow$  move 45° anticlockwise. So, option (d) is correct.

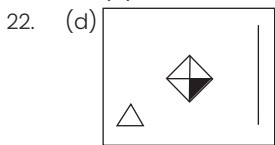

According to the question figure,  $\square$  moved one step clockwise and remove one side dark part of square move one step, two step, three step clockwise. So, option (d) is correct.

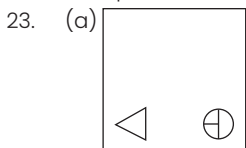

According to the question figure,  $\Delta$  moved one step clockwise and it also moved 90°. So, option (a) is correct.

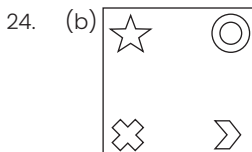

According to the question figure, all symbol moved one step clockwise. So, option (b) is correct.

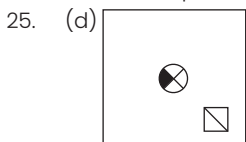

According to the question figure, circle moved 45° anticlockwise and square moved one step anticlockwise. So, option (d) is correct.

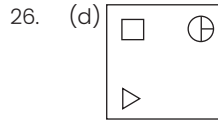

According to the question figure, all symbol moved one step clockwise. So, option (d) is correct.

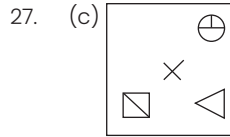

According to the question figure, circle moved one step anticlockwise, square moved one step anticlockwise and inside line is change. So, option (c) is correct.

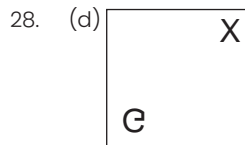

According to the question figure, right symbol changed and left symbol remove by right symbol. So, option (d) is correct.

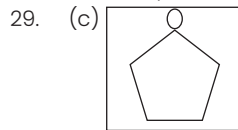

According to the question figure, circle moved two step clockwise. So, option (c) is correct.

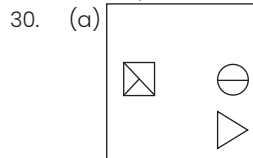

According to the question figure, circle moved one step clockwise. So, option (a) is correct.

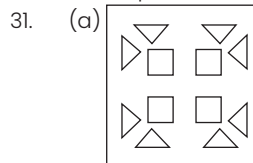

According to the question figure, paper fold three times. So, option (a) is correct.

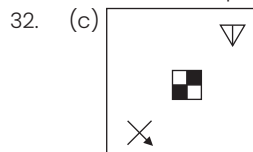

According to the question figure, triangle moved opposite corner. So, option (c) is correct.

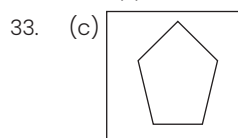

According to the question figure, in figure one line add. So, option (c) is correct.

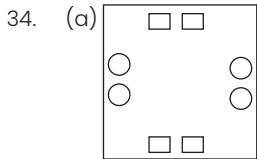

According to the question figure, paper fold three times, circle is four and square is four. So, option (a) is correct.

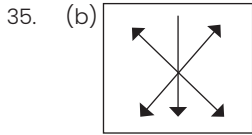

According to the question figure, the middle line moved 90° clockwise. So, option (b) is correct.

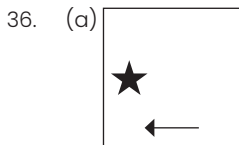

According to the question figure, → moved one step down and change direction and another symbol moved one step, two step, three step anticlockwise. So, option (a) is correct.

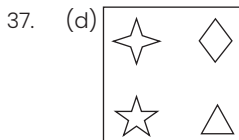

According to the question figure, left down corner symbol moved to right down corner and Right up corner symbol moved to left down corner. So, option (d) is correct.

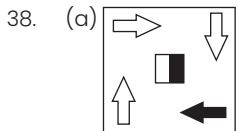

According to the question figure, all arrows moved one step anticlockwise, dark arrow moved two step and rectangle dark part moved opposite. So, option (a) is correct.

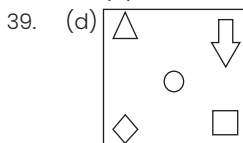

According to the question figure, o, Δ, ◇, moved one step clockwise, and □, ↓ replace. So, option (d) is correct.

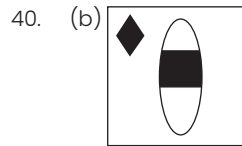

According to the question figure, square moved one step clockwise and first blank and next dark. In circle dark part moved one step. So, option (b) is correct.

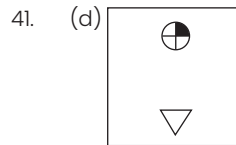

According to the question figure, circle and triangle replace each other and circle moved 90°. So, option (d) is correct.

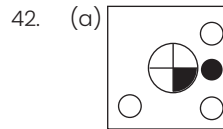

According to the question figure, Circle moved 90° anticlockwise. So, option (a) is correct.

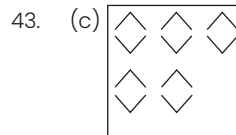

According to the question figure, symbol is added one more. So, option (c) is correct.

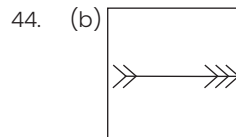

According to the question figure, In figure arrow (>) is add one more. So, option (b) is correct.

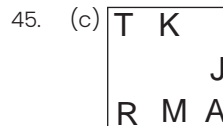

According to the question figure, all symbol are moved one step clockwise and three symbol are reverse. So, option (c) is correct.

## EXERCISE 17B

For SSC CHSL Exam

1. Select the correct answer.



SSC CHSL 26/10/2020 (Shift-3)

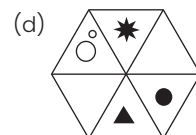
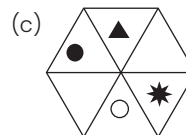
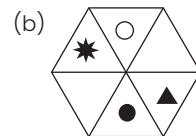
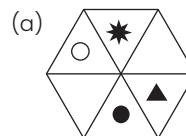

2. Select the correct answer.

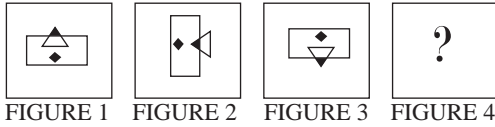

SSC CHSL 26/10/2020 (Shift-2)

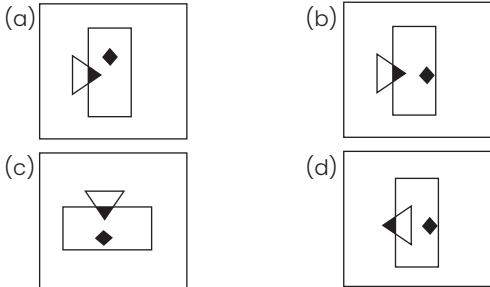

3. Select the correct answer.

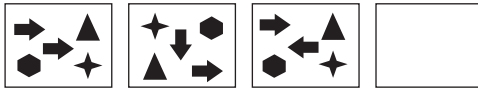

SSC CHSL 26/10/2020 (Shift-1)

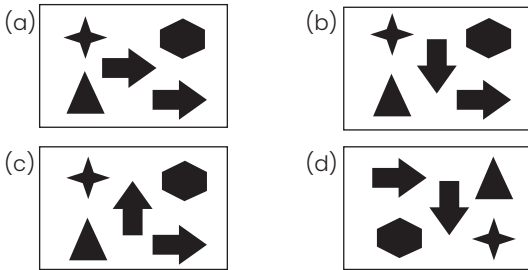

4. Select the correct answer.

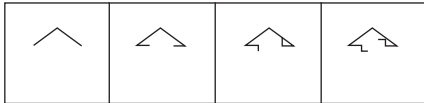

SSC CHSL 21/10/2020 (Shift-3)

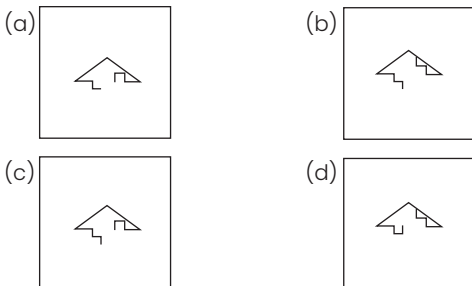

5. Select the correct answer.

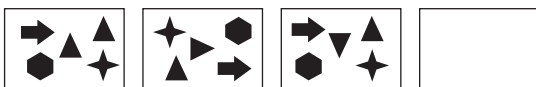

SSC CHSL 21/10/2020 (Shift-1)

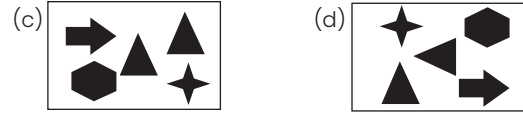

6. Select the correct answer.

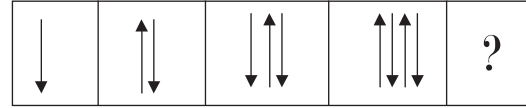

SSC CHSL 20/10/2020 (Shift-3)

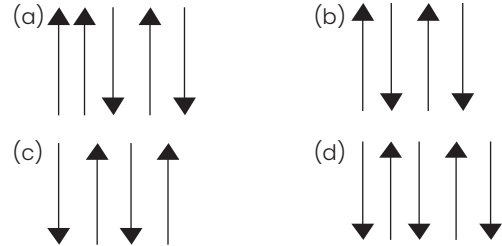

7. Select the correct answer.



SSC CHSL 20/10/2020 (Shift-2)

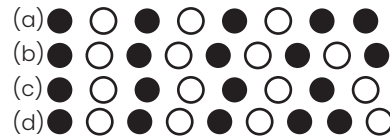

8. Select the correct answer.



SSC CHSL 19/10/2020 (Shift-3)

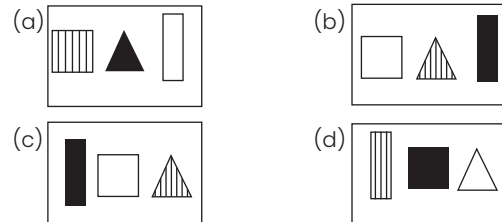

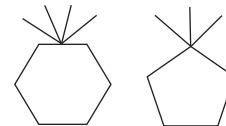

9. Select the correct answer.

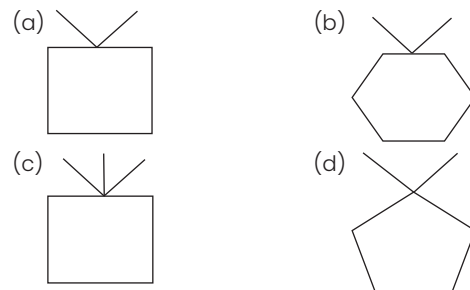

SSC CHSL 19/10/2020 (Shift-2)

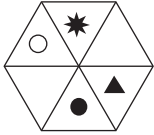
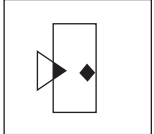
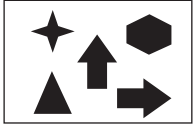

**SOLUTION**

1. (a) 
- According to the question figure, Δ and \* moved one step clockwise and •, o moved one step anticlockwise. So, option (a) is correct.
2. (b) 
- According to the question figure, the figure moved 90° clockwise and Δ changed their directions. So, option (b) is correct.
3. (c) 
- According to the question figure, bottom arrow moved 90° clockwise. So, option (c) is correct.
4. (b) 
- According to the question figure, two lines are added at the end of line in opposite direction. So, option (b) is correct.

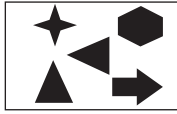
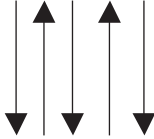
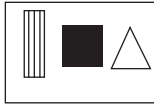
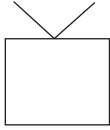
5. (d) 
- According to the question figure, bottom triangle moved 90° clockwise. So, option (d) is correct.
6. (d) 
- According to the question figure, one arrow is added and its direction in opposite. So, option (d) is correct.
7. (b) ● ○ ● ○ ● ○ ● ○ ●
- According to the question figure, two circles are added. So, option (b) is correct.
8. (d) 
- According to the question figure, the symbol moved one step left side and dark shape moved left side. So, option (d) is correct.
9. (a) 
- According to the question figure, one line is removed. So, option (a) is correct.

**EXERCISE 17C**

For SSC CGL and CPO Exams

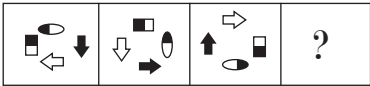
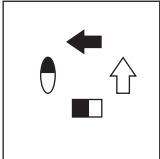
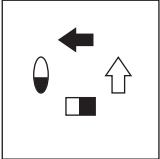
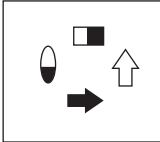
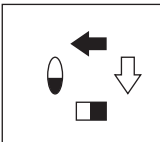
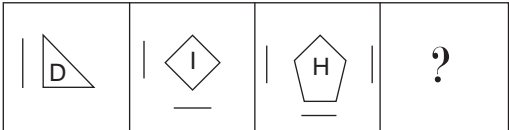
1. Select the correct answer.
- 
- SSC CGL 21/04/2022 (Shift-3)
- (a) 
- (b) 
- (c) 
- (d) 
2. Select the correct answer.
- 
- SSC CGL 21/04/2022 (Shift-2)

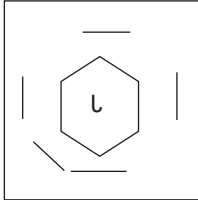
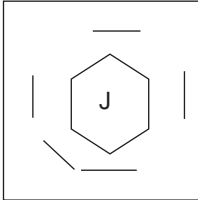
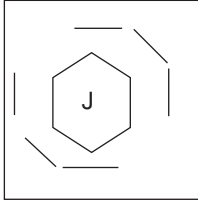
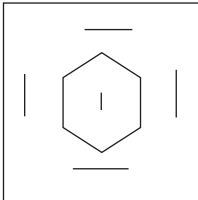
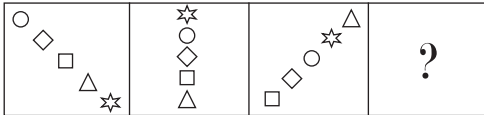
- (a) 
- (b) 
- (c) 
- (d) 
3. Select the correct answer.
- 
- SSC CGL 21/04/2022 (Shift-1)

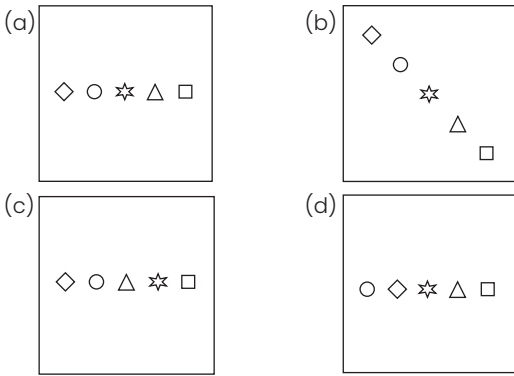

4. Select the correct answer.

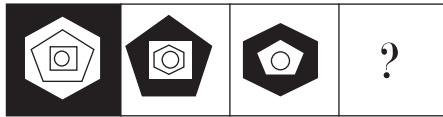

SSC CGL 20/04/2022 (Shift-3)

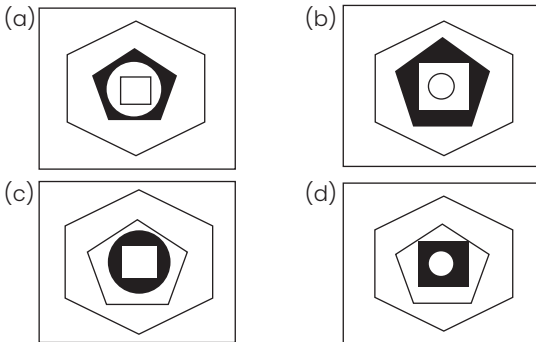

5. Select the correct answer.

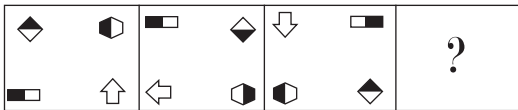

SSC CGL 20/04/2022 (Shift-2)

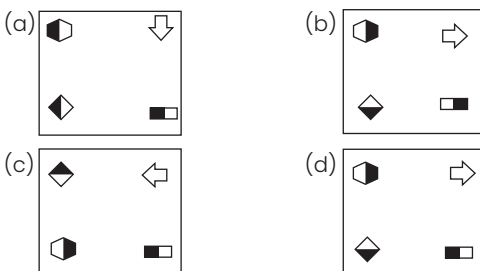

6. Select the correct answer.

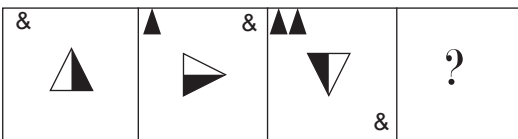

SSC CGL 20/04/2022 (Shift-1)

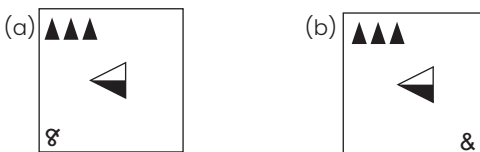

7. Select the correct answer.

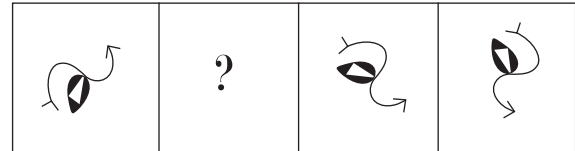

SSC CGL 19/04/2022 (Shift-3)

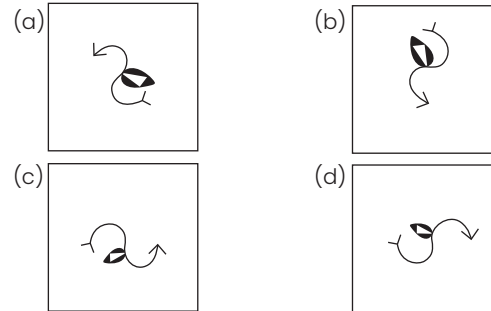

8. Select the correct answer.

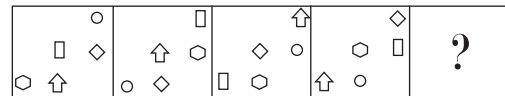

SSC CGL 19/04/2022 (Shift-2)

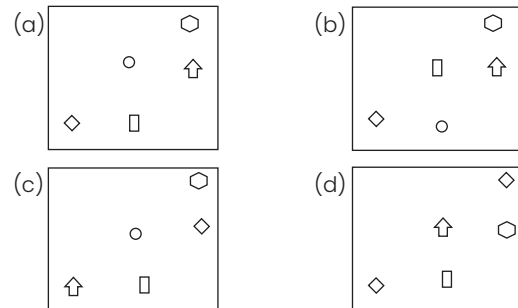

9. Select the correct answer.

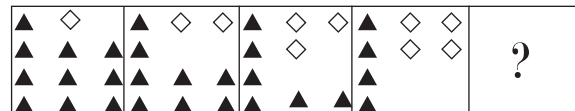

SSC CGL 19/04/2022 (Shift-1)

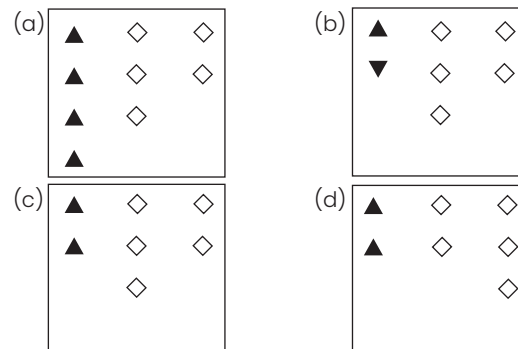

10. Select the correct answer.

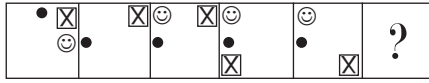

SSC CGL 18/04/2022 (Shift-3)

- (a)
- (b)
- (c)
- (d)

11. Select the correct answer.

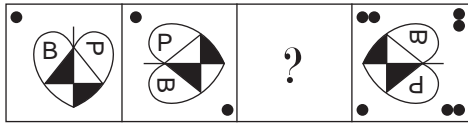

SSC CGL 18/04/2022 (Shift-2)

- (a)
- (b)
- (c)
- (d)

12. Select the correct answer.

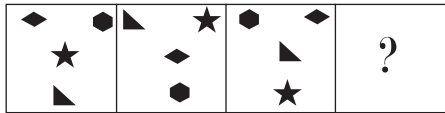

SSC CGL 18/04/2022 (Shift-1)

- (a)
- (b)
- (c)
- (d)

13. Select the correct answer.

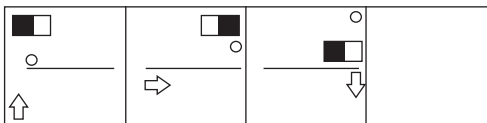

SSC CGL 13/04/2022 (Shift-3)

- (a)
- (b)
- (c)
- (d)

14. Select the correct answer.

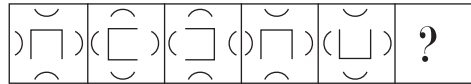

SSC CGL 24/08/2021 (Shift-3)

- (a)
- (b)
- (c)
- (d)

15. Select the correct answer.

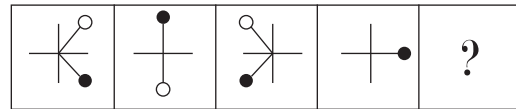

SSC CGL 24/08/2021 (Shift-2)

- (a)
- (b)
- (c)
- (d)

16. Select the correct answer.

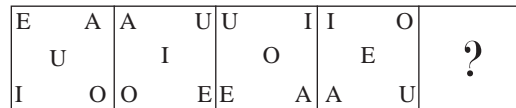

SSC CGL 24/08/2021 (Shift-1)

- (a) 

|   |   |
|---|---|
| A | E |
| U |   |
| I | O |
- (b) 

|   |   |
|---|---|
| O | E |
|   | I |
| U | A |
- (c) 

|   |   |
|---|---|
| O | E |
|   | A |
| U | I |
- (d) 

|   |   |
|---|---|
| E | A |
|   | U |
| I | O |

17. Select the correct answer.

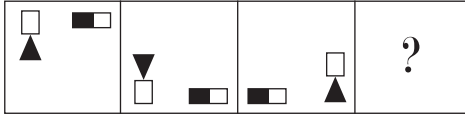

SSC CGL 23/08/2021 (Shift-3)

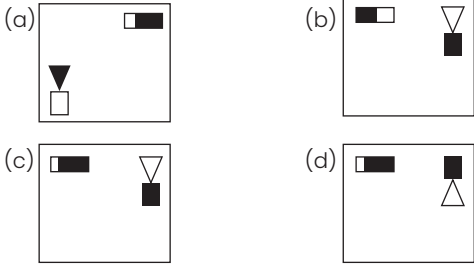

18. Select the correct answer.

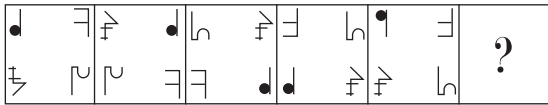

SSC CGL 23/08/2021 (Shift-2)

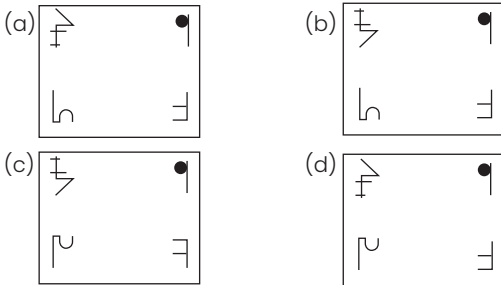

19. Select the correct answer.

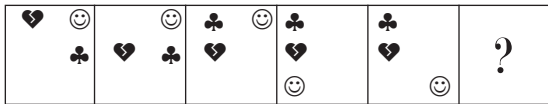

SSC CGL 23/08/2021 (Shift-1)

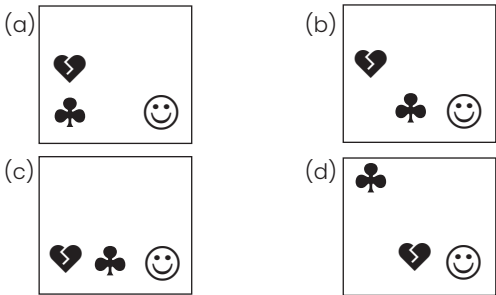

20. Select the correct answer.

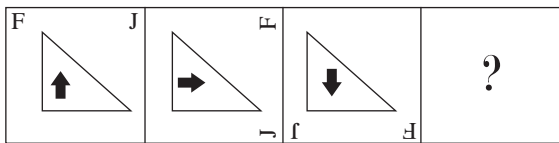

SSC CGL 20/08/2021 (Shift-3)

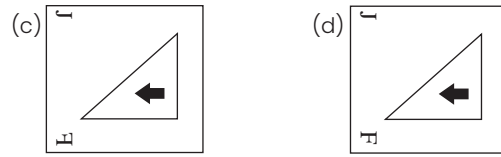
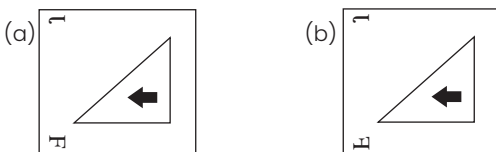

21. Select the correct answer.

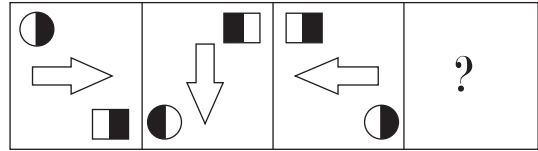

SSC CGL 20/08/2021 (Shift-2)

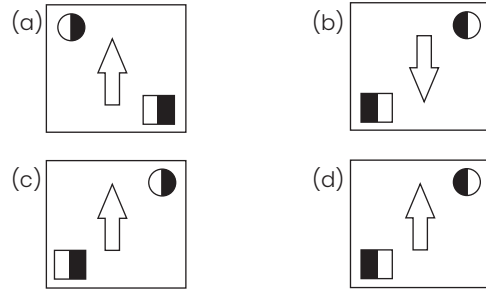

22. Select the correct answer.

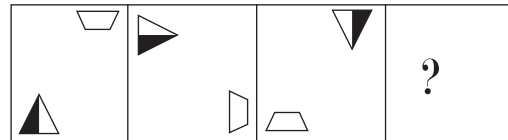

SSC CGL 20/08/2021 (Shift-1)

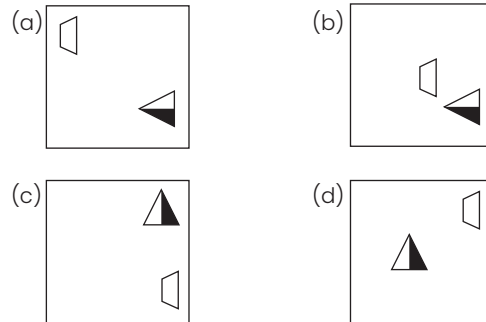

23. Select the correct answer.

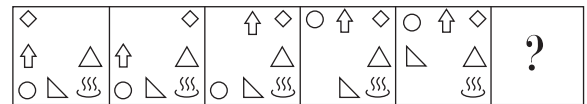

SSC CGL 18/08/2021 (Shift-3)

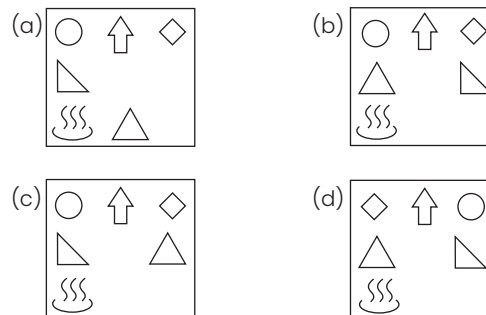

24. Select the correct answer.

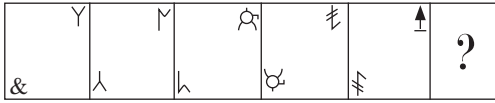

SSC CGL 18/08/2021 (Shift-2)

- (a)
- (b)
- (c)
- (d)

25. Select the correct answer.

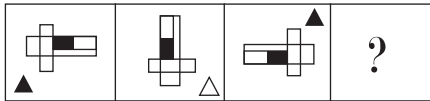

SSC CGL 18/08/2021 (Shift-1)

- (a)
- (b)
- (c)
- (d)

26. Select the correct answer.

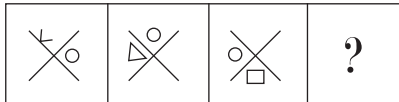

SSC CGL 17/08/2021 (Shift-3)

- (a)
- (b)
- (c)
- (d)

27. Select the correct answer.

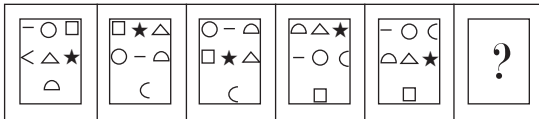

SSC CGL 17/08/2021 (Shift-2)

- (a)
- (b)
- (c)
- (d)

28. Select the correct answer.

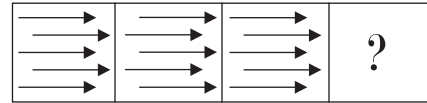

SSC CPO 25/11/2020 (Shift-3)

- (a)
- (b)
- (c)
- (d)

29. Select the correct answer.

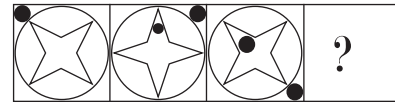

SSC CPO 25/11/2020 (Shift-3)

- (a)
- (b)
- (c)
- (d)

30. Select the correct answer.



SSC CPO 25/11/2020 (Shift-3)

- (a)
- (b)
- (c)
- (d)

31. Select the correct answer.

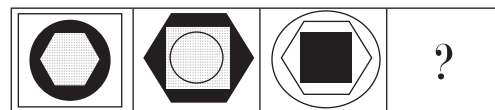

SSC CPO 25/11/2020 (Shift-1)

- (a)
- (b)
- (c)
- (d)



32. Select the correct answer.

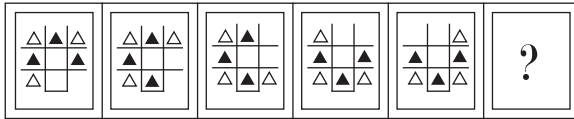

SSC CPO 25/11/2020 (Shift-1)

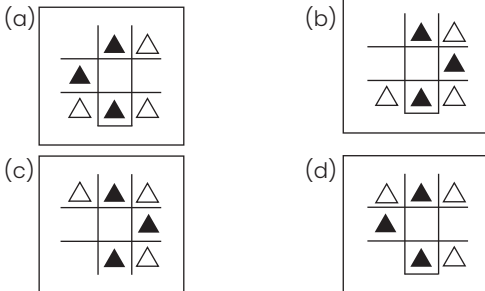

33. Select the correct answer.

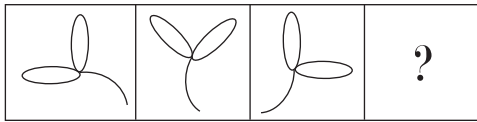

SSC CPO 25/11/2020 (Shift-1)

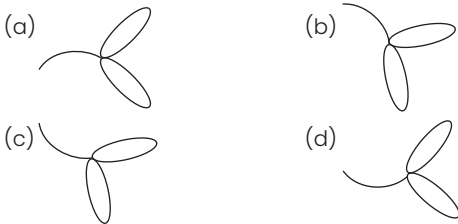

34. Select the correct answer.

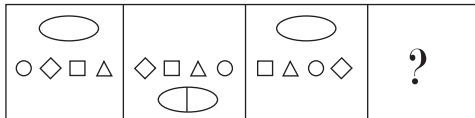

SSC CPO 24/11/2020 (Shift-3)

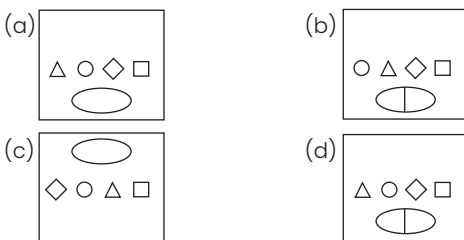

35. Select the correct answer.

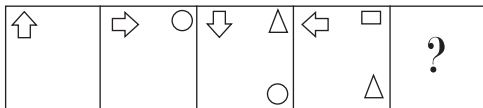

SSC CPO 24/11/2020 (Shift-3)

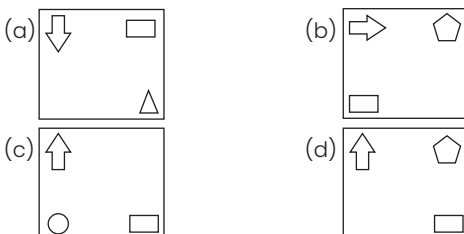

36. Select the correct answer.

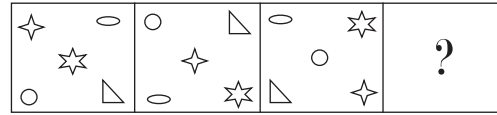

SSC CPO 24/11/2020 (Shift-3)

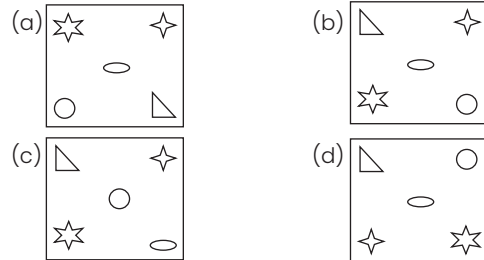

37. Select the correct answer.



SSC CPO 24/11/2020 (Shift-1)

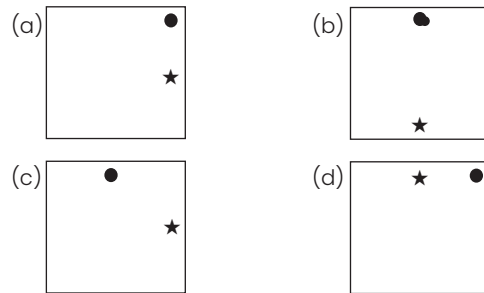

38. Select the correct answer.

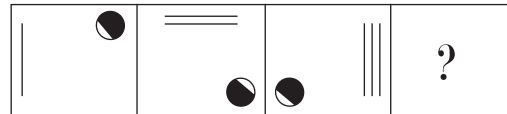

SSC CPO 24/11/2020 (Shift-1)

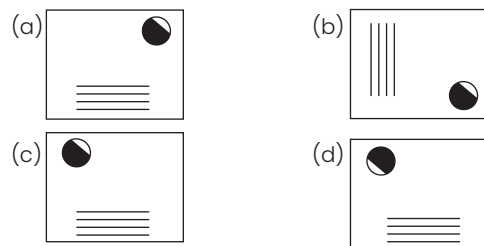

39. Select the figure that will replace the question mark (?) in the following figure series.

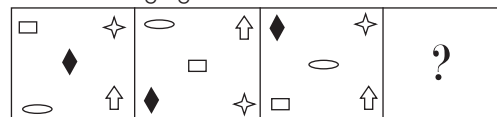

SSC CPO 24/11/2020 (Shift-1)

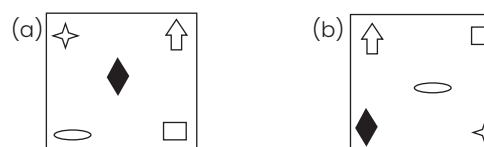

18 ■ SSC Reasoning

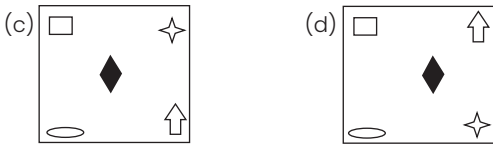

40. Select the correct answer.

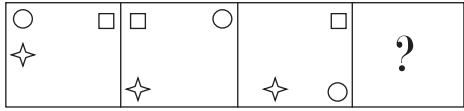

SSC CGL 07/03/2020 (Shift-2)

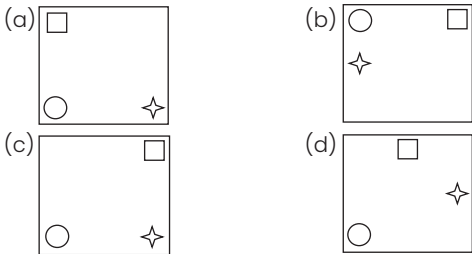

41. Select the correct answer.

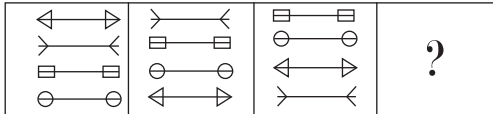

SSC CGL 07/03/2020 (Shift-1)

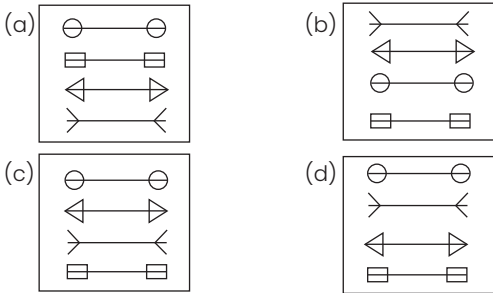

42. Select the correct answer.

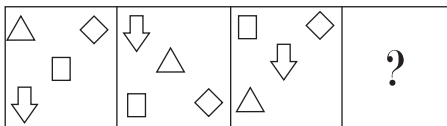

SSC CGL 06/03/2020 (Shift-3)

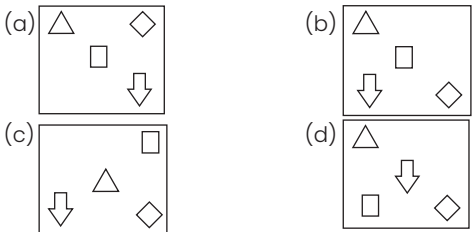

43. Select the correct answer.

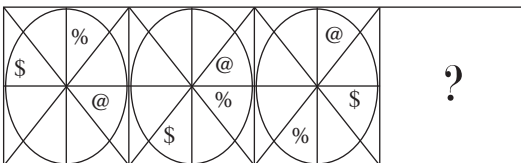

SSC CGL 06/03/2020 (Shift-2)

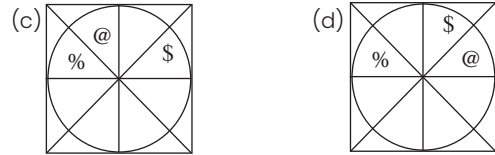
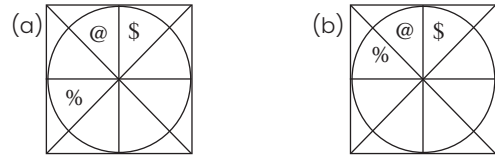

44. Select the correct answer.

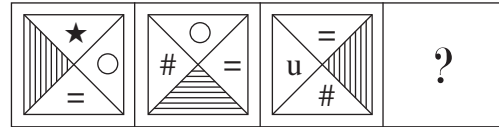

SSC CPO 13/12/2019 (Shift-3)

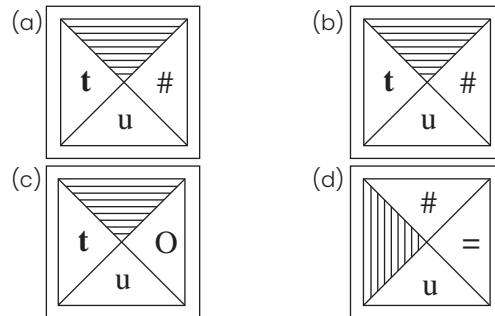

45. Select the correct answer.



SSC CPO 13/12/2019 (Shift-3)

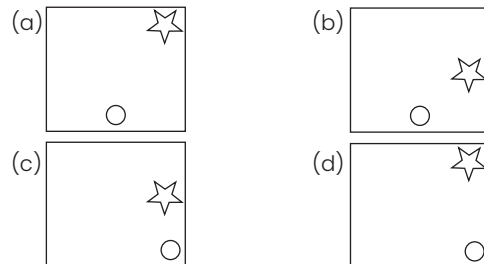

46. Select the correct answer.



SSC CPO 13/12/2019 (Shift-3)

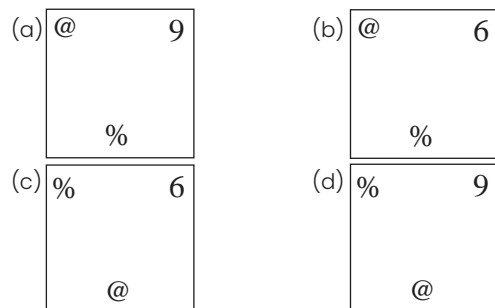

47. Select the correct answer.

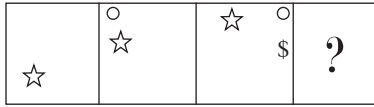

SSC CPO 13/12/2019 (Shift-1)

- (a) 

|    |   |   |
|----|---|---|
|    |   | * |
| \$ | ○ | ☆ |
- (b) 

|    |   |   |
|----|---|---|
|    |   | * |
| \$ | ○ | ☆ |
- (c) 

|    |   |   |
|----|---|---|
| *  |   |   |
| \$ | ○ | ☆ |
- (d) 

|   |  |    |
|---|--|----|
|   |  | ☆  |
|   |  | ○  |
| * |  | \$ |

48. Select the correct answer.

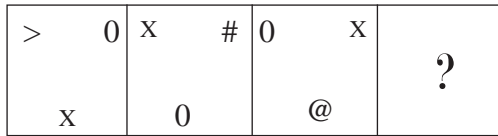

SSC CPO 13/12/2019 (Shift-1)

- (a) 

|   |   |
|---|---|
| X | 0 |
|   | % |
- (b) 

|   |   |
|---|---|
| X | 0 |
|   | > |
- (c) 

|   |   |
|---|---|
| 0 | % |
|   | X |
- (d) 

|   |   |
|---|---|
| % | 0 |
|   | X |

49. Select the correct answer.

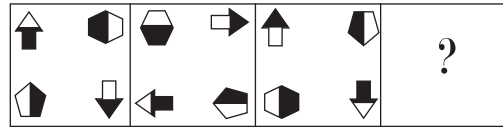

SSC CPO 13/12/2019 (Shift-1)

- (a) 

|   |   |
|---|---|
| ↑ | ◻ |
| ◻ | ↓ |
- (b) 

|   |   |
|---|---|
| ◻ | ◻ |
| ◻ | ◻ |
- (c) 

|   |   |
|---|---|
| ◻ | ↑ |
| ↓ | ◻ |
- (d) 

|   |   |
|---|---|
| ◻ | ↑ |
| ↓ | ◻ |

50. Select the correct answer.

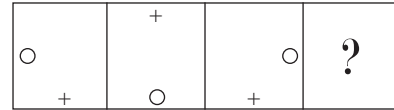

SSC CPO 12/12/2019 (Shift-3)

- (a) 

|    |
|----|
| +○ |
|----|
- (b) 

|   |
|---|
| ○ |
| + |
- (c) 

|   |
|---|
| ○ |
| + |
- (d) 

|   |
|---|
| + |
| ○ |

## SOLUTIONS

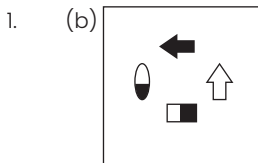

According to the question figure, all symbol moved one step clockwise and change in opposite direction. So, option (b) is correct.

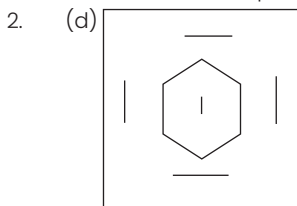

According to the question figure, one line added. So, option (d) is correct.

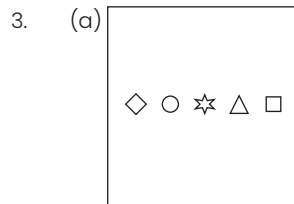

According to the question figure, all symbol make a line and this line moved 45° clockwise and last symbol moved at first. So, option (a) is correct.

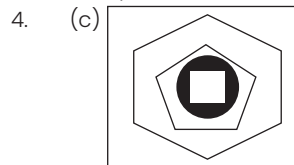

According to the question figure, the dark part moved to II<sup>nd</sup> next figure. So, option (c) is correct.

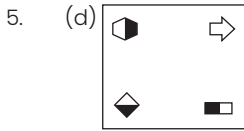

According to the question figure, all symbol moved one step clockwise and change their direction. So, option (d) is correct.

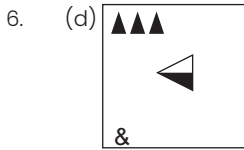

According to the question figure, one triangle is added and & is moved one step clockwise. So, option (d) is correct.

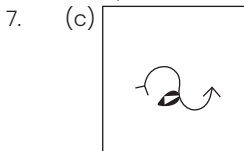

According to the question figure, figure moved 45° clockwise. So, option (c) is correct.

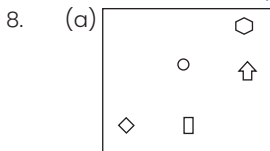

According to the question figure, right corner symbol moved to left corner symbol, down symbol moved to bottom. So, option (a) is correct.

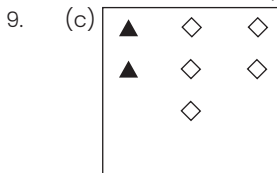

According to the question figure, two triangles are removed and one square is added. So, option (c) is correct.

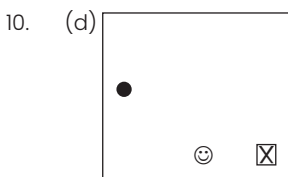

According to the question figure, first ● moved two steps anticlockwise and other figure ☺ is moved three step and then ☒ is moved four steps, now ☒ is moved two steps and ☺ is moved three step. So, option (d) is correct.

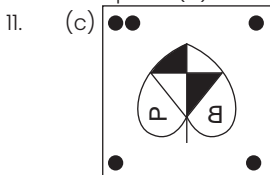

According to the question figure, figure moved 90° anticlockwise and dotted are added. So, option (c) is correct.

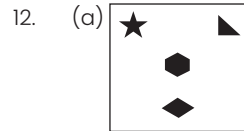

According to the question figure, outer symbol moved clockwise and bottom symbol replace by right corner symbol. So, option (a) is correct.

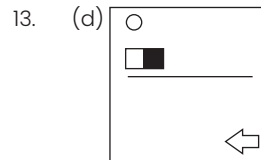

According to the question figure, rectangle and circle moved right side and arrow moved one step and rectangle and circle replace each other. So, option (d) is correct.

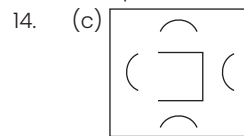

According to the question figure, figure is moved one step and two step anticlockwise and symbol change their direction. So, option (c) is correct.

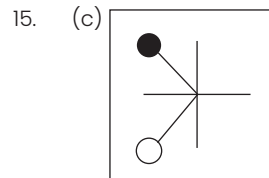

According to the question figure, → is moved 135° clockwise and ← is moved 135° anticlockwise. So, option (c) is correct.

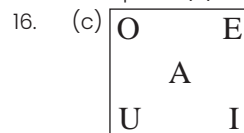

According to the question figure, left down corner moved to bottom. So, option (c) is correct.

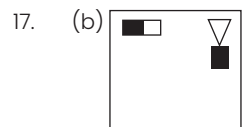

According to the question figure, ■□ moved one step clockwise and other symbol moved one step anticlockwise. So, option (b) is correct.

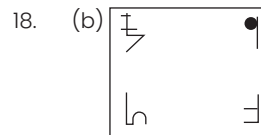

According to the question figure, all symbol moved one step clockwise and left corner symbol is reverse. So, option (b) is correct.

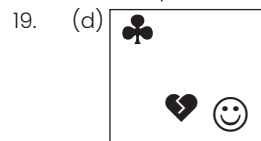

According to the question figure, ♥ moved two steps, ♣ moved three steps, © moved five steps. So, option (d) is correct.

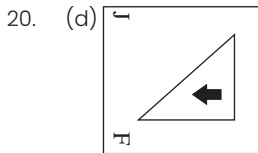

According to the question figure, symbol moved one step clockwise and symbol moved 90° anticlockwise also. So, option (d) is correct.

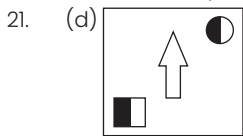

According to the question figure, symbol moved one step anticlockwise and reverse, arrow is moved 90° clockwise. So, option (d) is correct.

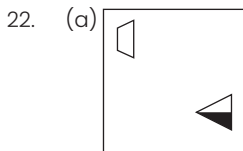

According to the question figure, ▱ is moved one step and moved also 90° anticlockwise. So, option (a) is correct.

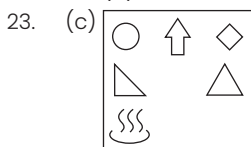

According to the question figure, only one symbol moved two step clockwise. So, option (c) is correct.

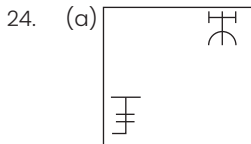

According to the question figure, right corner symbol moved left corner and right corner changed new symbol. So, option (a) is correct.

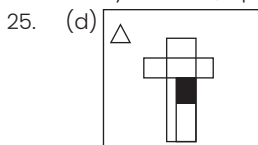

According to the question figure, figure moved 90° anticlockwise and triangle moved one step anticlockwise. So, option (d) is correct.

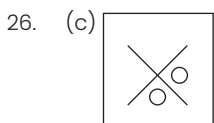

According to the question figure, symbol moved one step anticlockwise and one line is added. So, option (c) is correct.

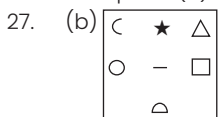

According to the question figure, some symbol moved one step anticlockwise and some moved two steps anticlockwise. So, option (b) is correct.

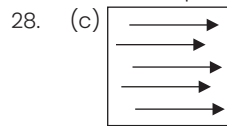

According to the question figure, II and IV arrow moved to back and next II and IV moved to ahead. So, option (c) is correct.

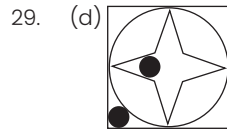

According to the question figure, inner figure moved 45° anticlockwise and outer figure moved one step clockwise. So, option (d) is correct.



According to the question figure, 1<sup>st</sup> is blank and other is dark, next 11<sup>nd</sup> is blank and other is dark. So, option (a) is correct.

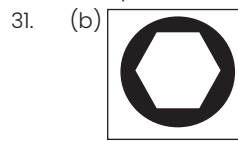

According to the question figure, inner shape moved to outer and dark part moved to outer side. So, option (b) is correct.

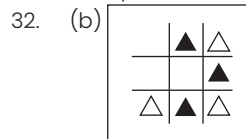

According to the question figure, the last symbol moved two steps clockwise. So, option (b) is correct.

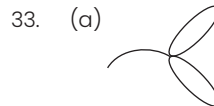

According to the question figure, figure moved 45° clockwise and its direction is changed. So, option (a) is correct.

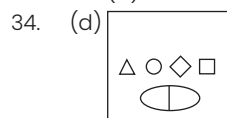

According to the question figure, left symbol moved at last symbol and circle move down and again up. So, option (d) is correct.

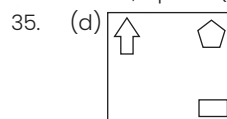

According to the question figure, arrow is moved 90° clockwise. One symbol is added. So, option (d) is correct.

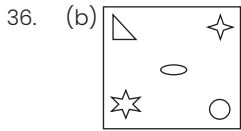

According to the question figure, left down symbol moved to left up and right down to right up and left up symbol moved to bottom. So, option (b) is correct.

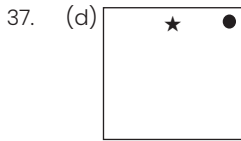

According to the question figure, dotted moved one step and next two steps and next three steps clockwise. And star moved same as dotted but anticlockwise. So, option (d) is correct.

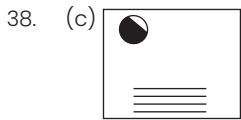

According to the question figure, circle moved one step clockwise and darker part moved opposite. So, option (c) is correct.

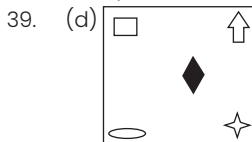

According to the question figure, right corner symbol moved up to down and other symbol moved to clockwise. So, option (d) is correct.

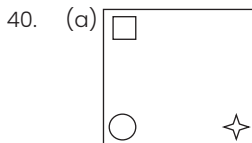

According to the question figure, circle moved two step clockwise ☆ is moved one step clockwise. So, option (a) is correct.

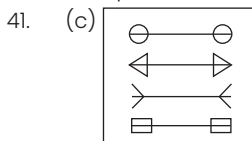

According to the question figure, 1<sup>st</sup> line moved to last line. So, option (c) is correct.

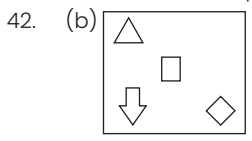

According to the question figure, right corner symbol moved up to down. And another symbol moved clockwise. So, option (b) is correct.

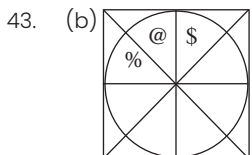

According to the question figure, \$ moved two steps and @ moved one step anticlockwise, % moved two steps clockwise. So, option (b) is correct.

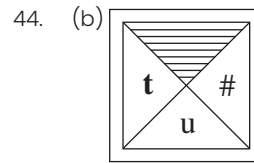

According to the question figure, figure moved anticlockwise and one symbol is changed. So, option (b) is correct.

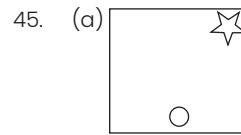

According to the question figure, o is moved one step anticlockwise, and ☆ is moved one step clockwise. So, option (a) is correct.

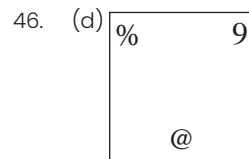

According to the question figure, symbol moved anticlockwise and one symbol is reversed. So, option (d) is correct.

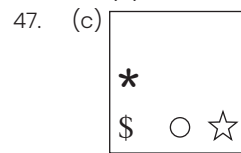

According to the question figure, ☆ is moved one step clockwise, and one another new symbol is added. So, option (c) is correct.

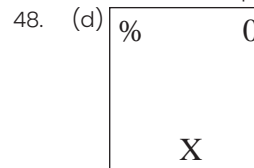

According to the question figure, left corner symbol moved up and replace by new symbol. All symbol moved clockwise. So, option (d) is correct.

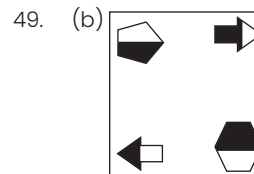

According to the question figure, all symbols moved anticlockwise. So, option (b) is correct.

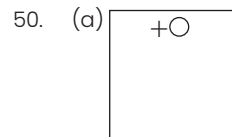

According to the question figure, circle moved one step anticlockwise. So, option (a) is correct.